

Model No : JY043W

■ PACKAGE DIMENSIONS :

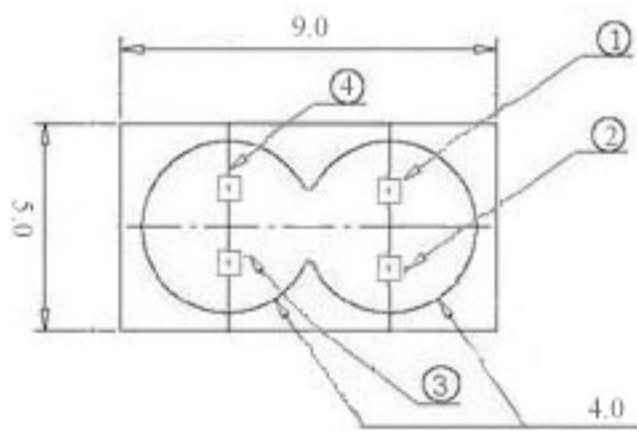
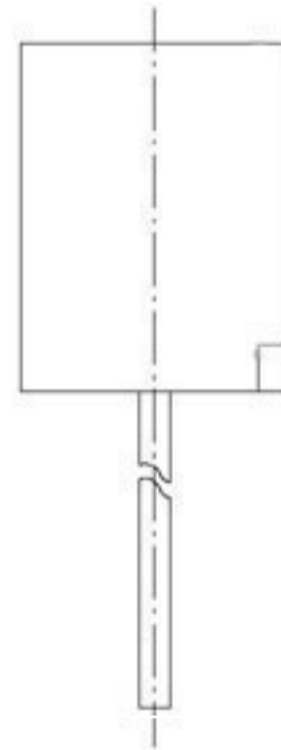
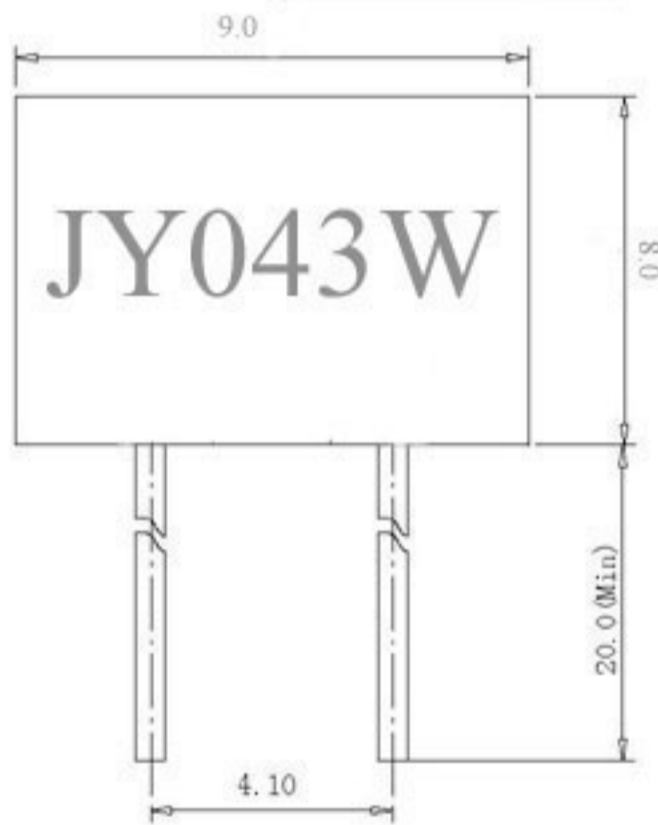
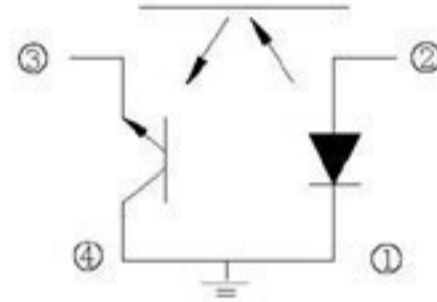
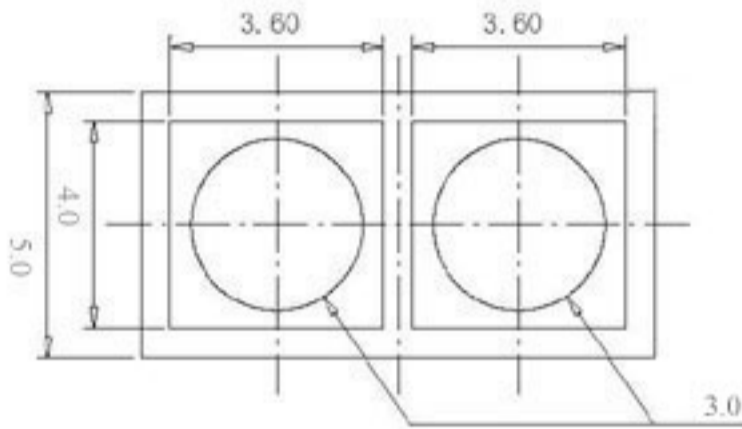

www.junyedz.com

- ① : Cathode
- ② : Anode
- ③ : Emitter
- ④ : Collector



Model No : JY043W

■ ABSOLUTE MAXIMUM RATINGS (Ta=25°C)

Parameter		Symbol	Ratings	Unit
Input	Power Dissipation	Pd	75	mW
	Reverse Voltage	V _R	5	V
	Forward Current	I _F	50	mA
	Peak Forward Current (*1)	I _{FP}	1	A
Output	Collector Power Dissipation	PC	75	mW
	Collector Current	I _C	20	mA
	Collector-Emitter Voltage	V _{CE}	30	V
	Emitter-Collector Voltage	V _{EC}	5	V
Operating Temperature		Topr	-25~+85	°C
Storage Temperature		Tstg	-40~+85	°C
Soldering Temperature (*2)		Tsol	260	°C

(*1) tw=100 μsec. , T=10 msec. (*2) t=5 Sec

■ ELECTRICAL CHARACTERISTICS (Ta=25°C)

Parameter		Symbol	Min.	Typ.	Max.	Unit	Conditions
Input	Forward Voltage	V _{F1}	-	1.2	1.5	V	I _F =20mA
		V _{F2}	-	1.4	1.85	V	I _F =100mA
		V _{F3}	-	2.6	4.0	V	I _F =1A
	Reverse Current	I _R	-	-	10	μA	V _R =5V
	Peak Wavelength	λ _P	-	940	-	nm	-
	View Angle	2□1/2	-	40	-	Deg	I _F =20mA
Output	Dark Current	I _{CEO}	-	-	100	nA	V _{CE} =10V
	C-E Saturation Voltage	V _{CE} (sat)	-	-	0.4	V	I _C =2mA I _B =0.1mA
Collector Current		I _{C(ON)}	0.7	-	2.6	mA	V _{CE} =3V
Leakage Current		I _{CEOD}	-	-	1	μA	I _F =40mA
Speed	Rise time	t _R	-	15	-	μsec	V _{CE} =2V
	Fall time	t _F	-	15	-	μsec	I _C =100 μA R _L =1KΩ

Opto Reflective Sensor



Model No : JY043W

TYPICAL CHARACTERISTICS FOR IR

Fig. 1 Forward Current vs. Ambient Temperature

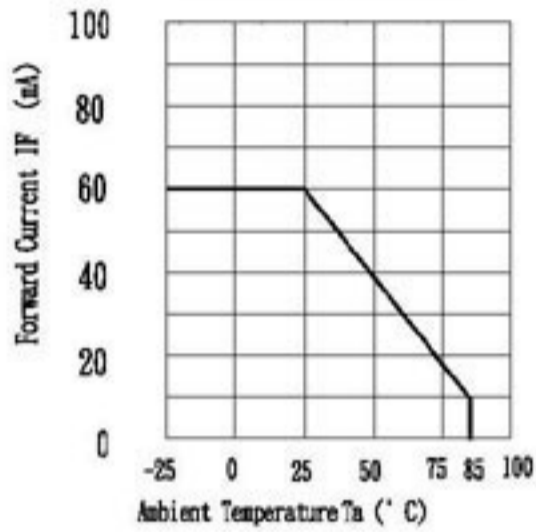

Fig. 2 Spectral Distribution

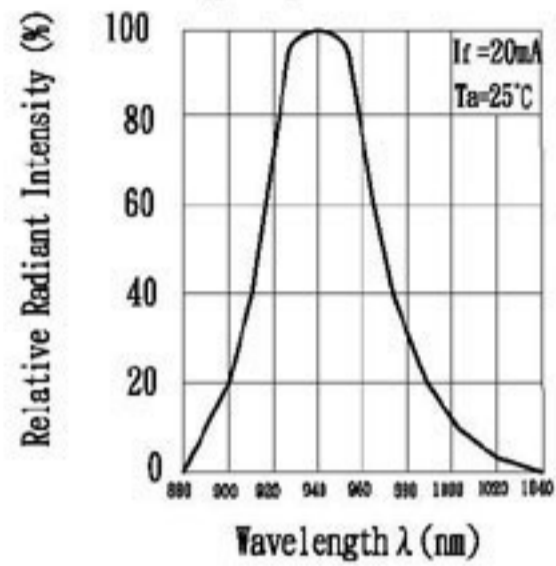

Fig. 3 Peak Emission Wavelength vs. Ambient Temperature

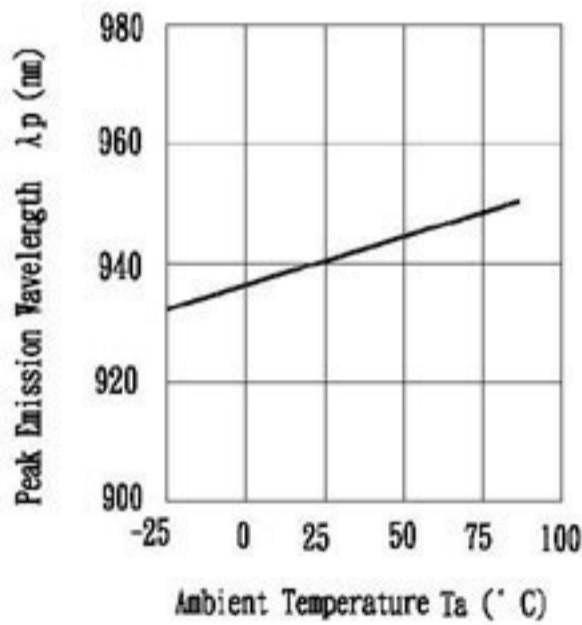

Fig. 4 Forward Current vs. Forward Voltage

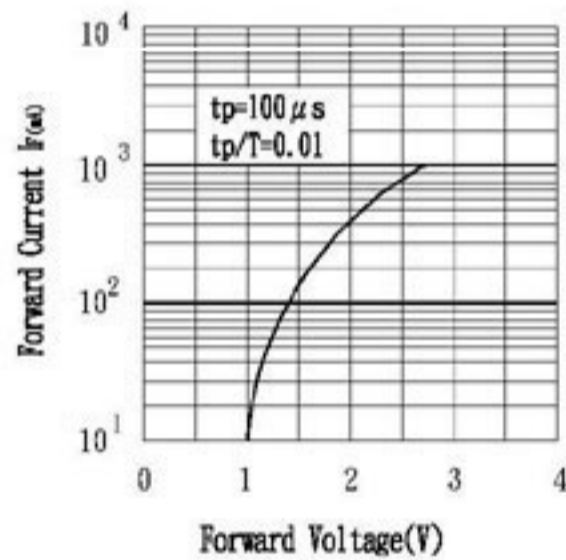

Fig. 5 Relative Intensity vs. Forward Current

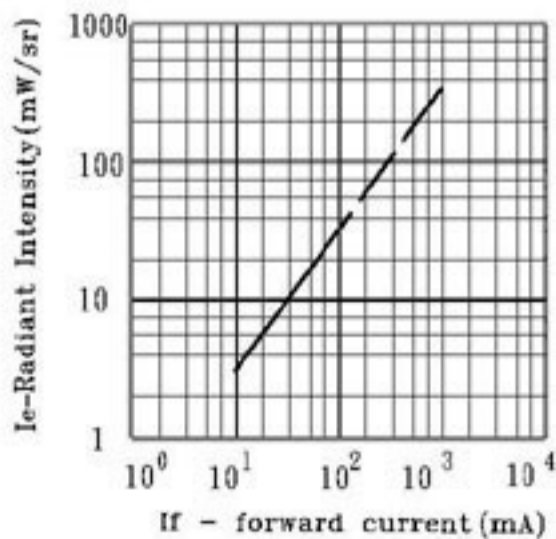
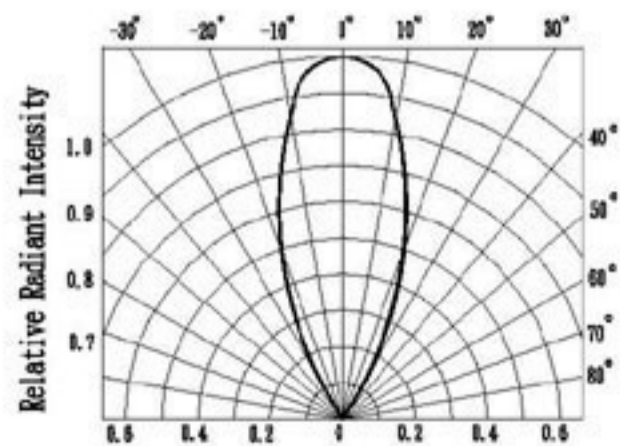
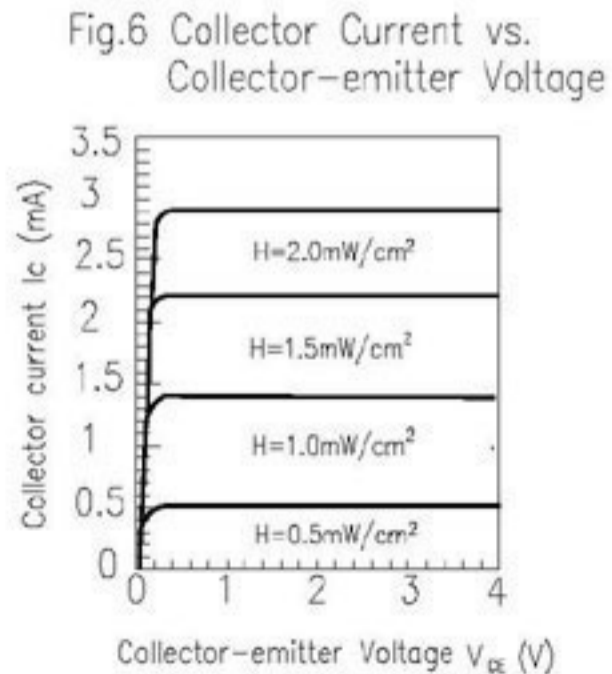
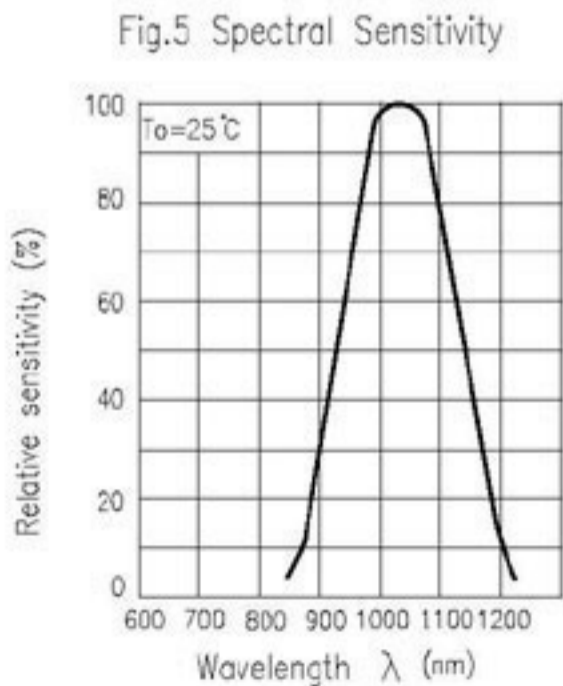
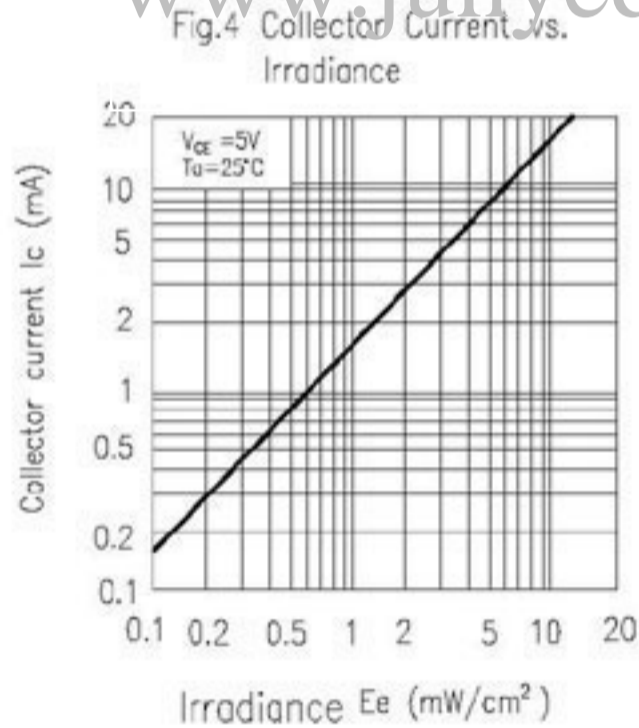
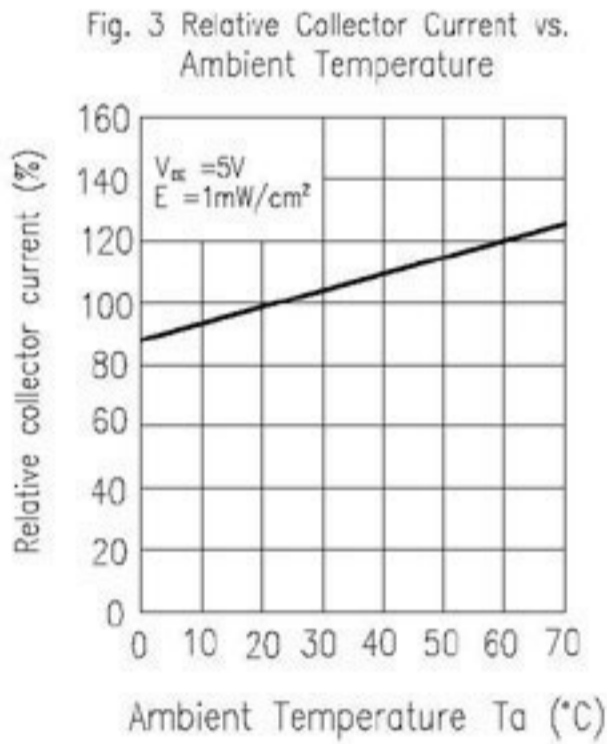
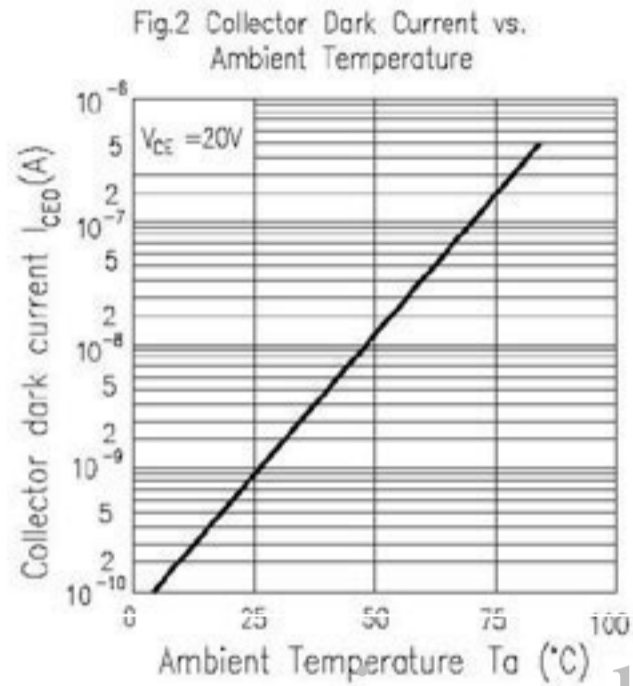
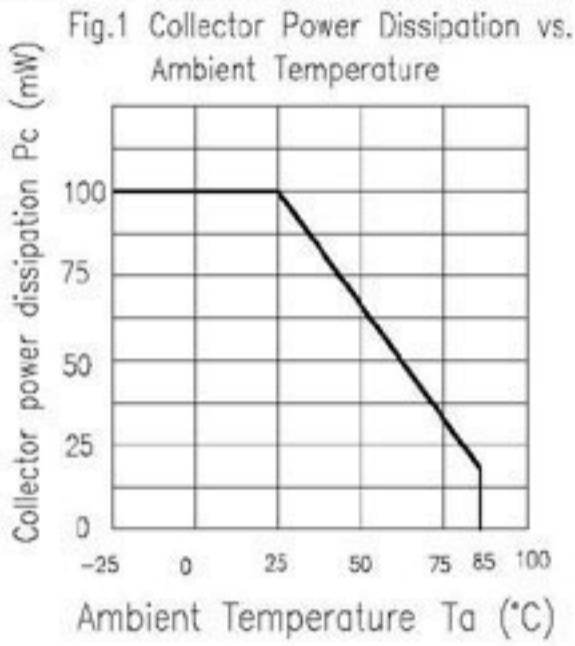

Fig. 6 Relative Radiant Intensity vs. Angular Displacement



Model No : JY043W

■ TYPICAL CHARACTERISTICS FOR PT



Model No : JY043W

■ RELIABILITY TEST ITEM AND CONDITION

The reliability of products shall be satisfied with items listed below.

Confidence level : 90%

LTPD : 10%

Items	Purpose & Condition	Failure Judgement Criteria	Samples (n) Defective (c)
Temperature Cycle	Evaluates product's ability to withstand exposure to high temperature, low temperature, and temperature variation between two limit temperature. Standard test Condition: 85°C ~ 25°C ~ -55°C ~ 25°C ↓ ↓ ↓ ↓ 30min 5min 30min 5min 50 cycle	$I_R \geq U \times 2$ $I_c(\text{on}) \leq L \times 0.8$ $V_F \geq U \times 1.2$ U : Upper specification limit	n = 22 , c = 0
Thermal Shock	Evaluates product's ability to withstand rapid temperature change Standard test Condition: 85°C ~ -55°C 5min (10sec) 5min 50cycle	L : Lower specification limit	n = 22 , c = 0
High Temperature Storage	Evaluates product's ability to withstand prolonged storage at high temperature Standard test Condition: Temperature : 100 °C Time : 1000hrs		n = 22 , c = 0
Low Temperature Storage	Evaluates product's ability to withstand prolonged storage at low temperature Standard test Condition: Temperature : -55 °C Time : 1000hrs		n = 22 , c = 0

www.junyedz.com

Model No : JY043W

Items	Purpose & Condition	Failure Judgement Criteria	Samples(n)
			Defective(c)
Operating Life	Evaluates product's endurance to prolonged electrical or temperature stresses. Standard test Condition: $V_{CE}=5V$ $I_F=20mA$ Time : 1000hrs	$I_R \geq U \times 2$ $I_c(on) \leq L \times 0.8$ $V_F \geq U \times 1.2$	n =22 , c=0
High Temperature High Humidity	Evaluates product's ability to withstand prolonged storage at high temperature and high humidity. Standard test Condition: Temperature: 85°C Relative humidity:85% Time : 1000hrs	U : Upper specification limit L : Lower specification limit	n =22 , c=0
Soldering Heat	Evaluates product's ability to withstand soldering heat Standard test conditions Solder temperature : 260±5°C Solder time : 10 seconds		n =22 , c=0

Supplement

1. Parts

(1) Chip

Type	Material	Peak Wavelength
IR	GaAlAs	940nm
PT	Silicon	860nm

(2) Material

Type	Lead frame	Wire	Package	Holder
JY	SPCC	Gold	Epoxy	NORYL