

Technical Data Sheet- Light Transmitting Unit Model No: JYT-18A

Features

- High speed signal transmission (16Mbps, NRZ signal)
- Input TTL compatible
- +3~+5V power source

Descriptions

The light transmitting unit is a standard-package product with connector and opto-electric component packaged with LED and drive IC. The function of unit changes the electric signal into light signal and be transmitted by plastic fiber.

The unit is operated at single+3V~ +5V and the input signal is TTL compatible. The JYT-18A has a maximum operating speed of 16 Mbps. The light signal is coupled into plastic fiber by connector. The unit has high performance at low dissipation current, steady light output and efficient light coupling.

Applications

- Audio equipment
- DVD player
- PC, Notebook
- Sound card

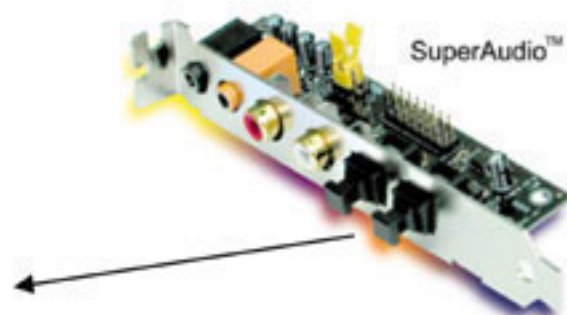

Device Selection Guide

Chip		Operating Voltage (Vcc)	Dissipation Current(mA)	Fiber Coupling Light Output (dBm)		
IC Material	LED λ p(nm)			Typ.	Min.	Typ.
Si	650	2.7~5.5	5	-21	-	-15

Technical Data Sheet- Light Transmitting Unit Model No: JYT-18A

Package Dimensions

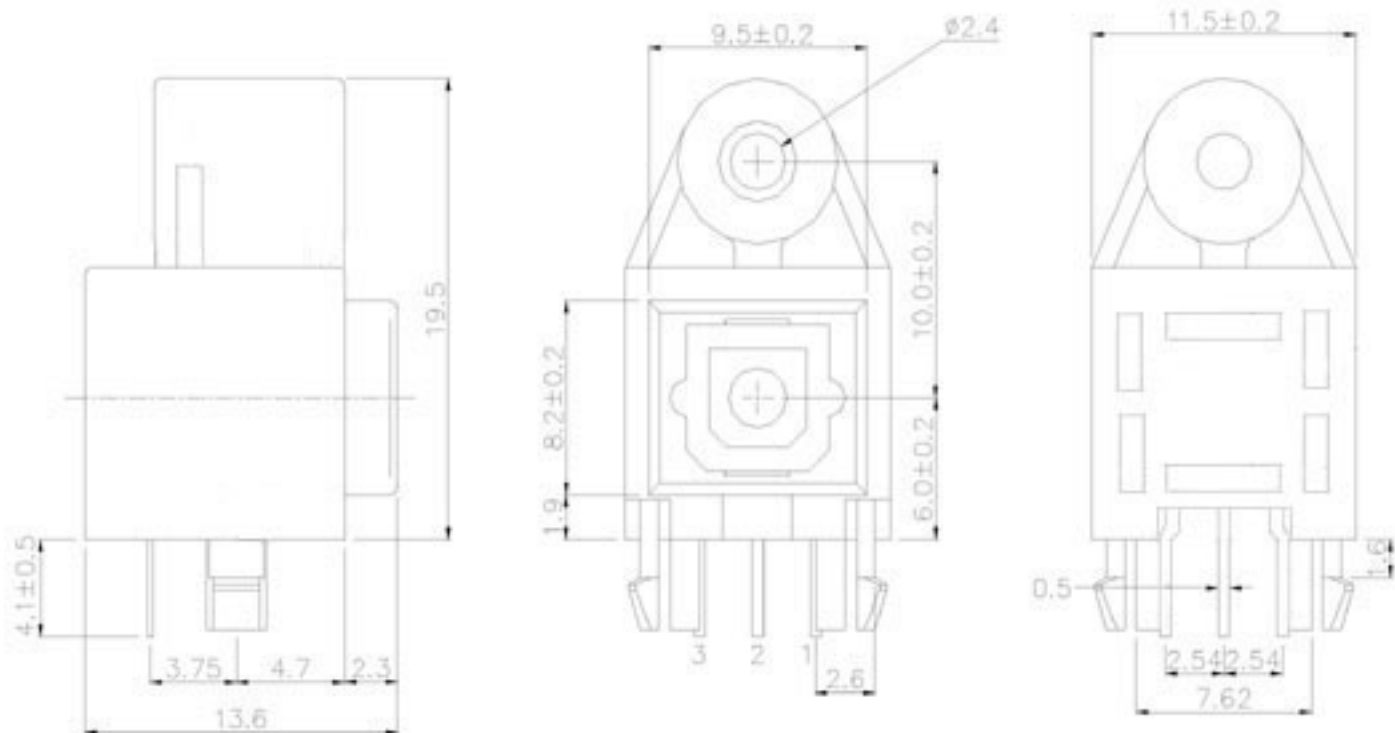

- Notes:** 1. All dimensions are in millimeters.
2. General Tolerance: ± 0.2 mm

Pin Function

1. GND
2. Vcc
3. Vin



Absolute Maximum Ratings(Ta = 25°C)

Parameter	Symbol	Rating	Unit
Supply Voltage	Vcc	-0.5 to 7	V
DC Input Voltage	Vin	-0.5 to Vcc+0.5	V
Power Dissipation	P	120	mW
Storage Temperature	Tstg	-30 to 80	°C
Operating Temperature	Topr	-20 to 70	°C
Soldering Temperature	Tsol	260*	°C

* Soldering time ≤ 5 s / 2 times.



Technical Data Sheet- Light Transmitting Unit
Model No: JYT-18A

Electro-Optical Characteristics

Parameter	Symbol	Conditions	MIN.	TYP.	MAX.	Unit
Operating Voltage	V _{cc}	-	2.7	-	5.5	V
Peak Emission Wavelength	λ_p	-	640	-	670	nm
Transmission Speed		NRZ signal	-	-	16	Mbps
Transmission Distance		Using APF*	0.2	-	20	m
Pulse Width Distortion	Δtw	16Mbps NRZ Signal	-25	-	25	ns
Fiber Coupling Light Output	P _f	*1	-21	-17	-15	dBm
Dissipation Current	I _{cc}	*2	-	5	10	mA
High Level Input Voltage	V _{IH}		2	-	-	v
Low Level Input Voltage	V _{IL}		-	-	0.8	v
Rise Time	t _r	*3	-	30	40	ns
Fall Time	t _f	*3	-	20	30	ns
Low → High propagation delay time	t _{PLH}	*3	-	-	100	ns
High → Low propagation delay time	t _{PHL}	*3	-	-	100	ns
Jitter	Δt_j	*3	-	1.5	15	ns

*Light output after APF should satisfy P_f range.

Technical Data Sheet- Light Transmitting Unit Model No: JYT-18A

Reliability Test Items

No.	Item	Test Condition	Test Hour/Cycle	Samples	Number (n) Failure (c)
1	Soldering Heat	260°C±5°C	5 sec./2times	22	n=22, c=0
2	High temp. & Hum. storage	Ta=40°C, 90%RH	500	22	n=22, c=0
3	High temp. storage	Ta=80°C	500	22	n=22, c=0
4	Low Temp. storage	Ta=-30°C	500	22	n=22, c=0
5	Temp. cycling	-30°C ~ 80°C (30min) (30min)	20	22	n=22, c=0
6	High Temp. Operation life	Ta=60°C, Vcc=5V ON	500	22	n=22, c=0
7	Repeated operation	500 times	Coupling force < 2 kg 0.4 kg<Detaching force <2kg	22	n=22, c=0
8	Terminal Strength(tension)	Weight: 500 g 30 sec./each terminal		22	n=22, c=0
9	Terminal Strength(bending)	Weight: 500 g 2 times/each terminal		22	n=22, c=0
10	Mechanical Shock	Acceleration: 1000 m/s ² Pulse width: 6 ms 3 times/ X,Y,Z direction		22	n=22, c=0
11	Vibration	Frequency range: 10~55 Hz /sweep 1 min Overall amplitude: 1.5 mm 2H./X,Y,Z direction		22	n=22, c=0

I_{cc} (dissipation current): CURRENT ATTENUATE DIFFERENCE < 20%

P_f (fiber coupling light output): BRIGHTNESS ATTENUATE DIFFERENCE < 20%

T_{PLH} (propagation L→ H delay time): DELAY TIME DIFFERENCE < 20%

T_{PHL} (propagation H→ L delay time): DELAY TIME DIFFERENCE < 20%

T_r (rise time): TIME DIFFERENCE < 20%

T_f (fall time): TIME DIFFERENCE < 20%

Technical Data Sheet- Light Transmitting Unit Model No: JYT-18A

PCB Layout For Electrical Circuit

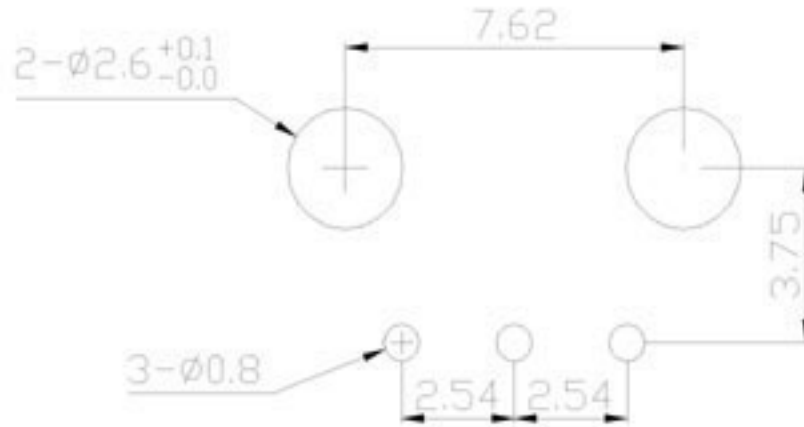

Notes:

1. Unit:mm
2. Unspecified tolerance: ± 0.3 mm
3. Substrate Thickness:1.6mm

Precautions for Using Method

1. Connect a by-pass capacitor (0.1uF) close to the JYT-18A within 7 mm of the unit lead frame.
2. Take proper electrostatic-discharge (ESD) precautions while handling these devices. These devices are sensitive to ESD.
3. Please follow the conditions described in the diagram below.

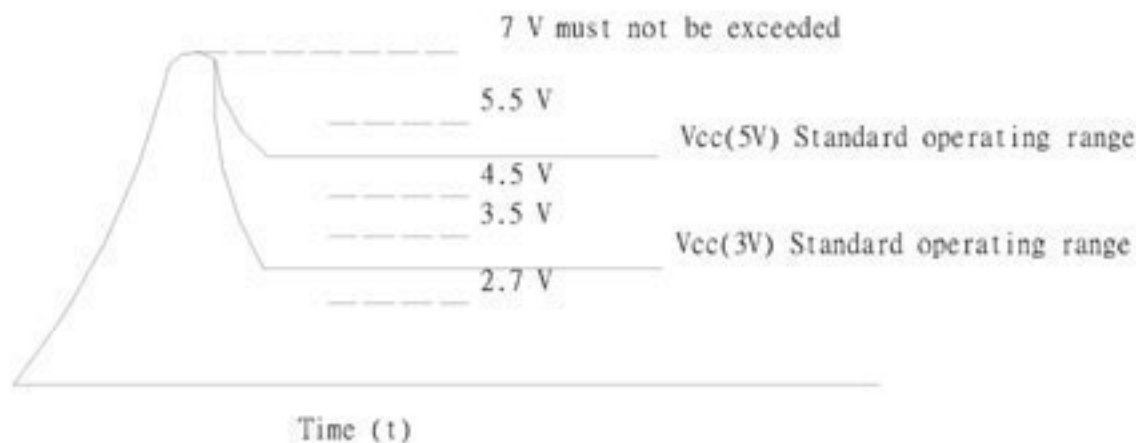
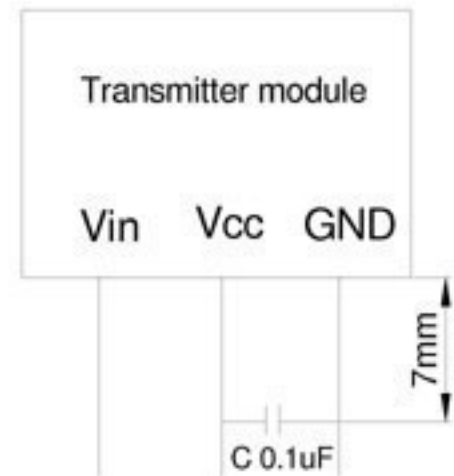

Technical Data Sheet- Light Transmitting Unit Model No: JYT-18A

Measuring Method

*1 Measuring method of optical output coupling fiber

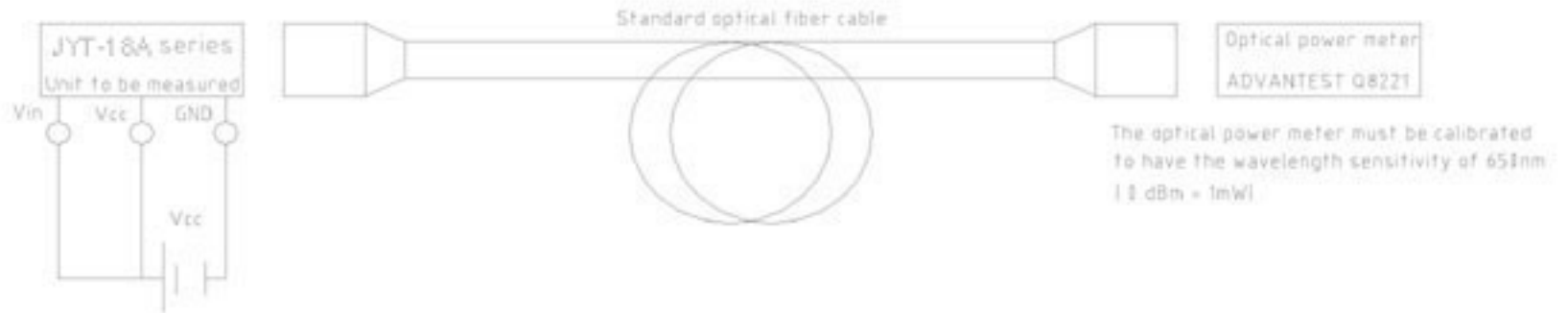

*2 Input voltage/power dissipation measuring method

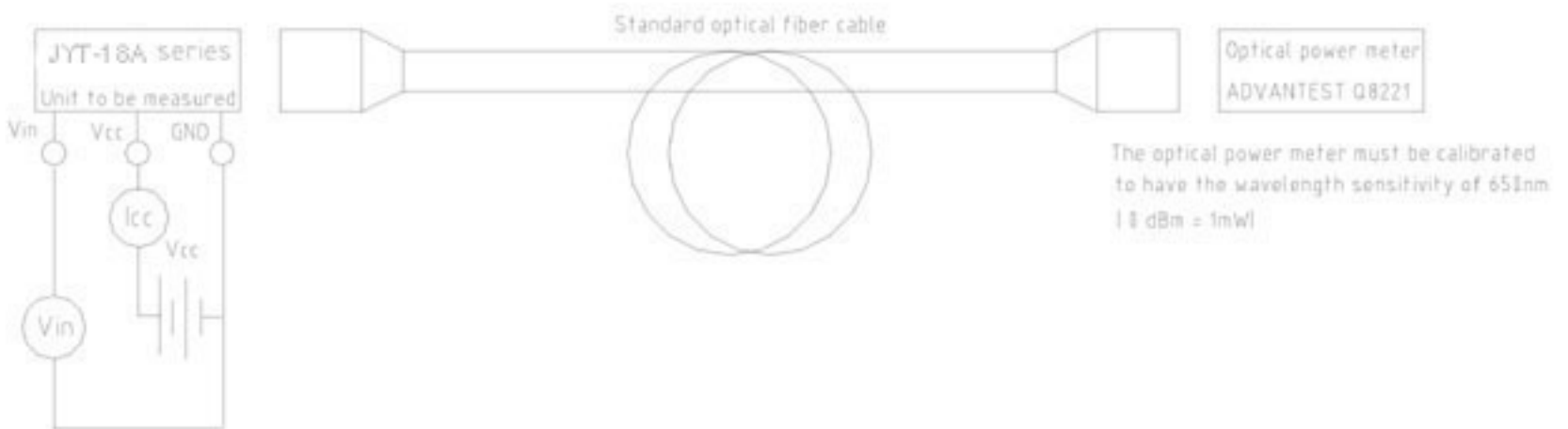

*3 Pulse response and jitter measuring method

